

# PROYECTO DE TRABAJO - 82

## MESA EDÉN

(Basado en un diseño original de D. Ezan para R. Bobois)



**ALUMNO:**

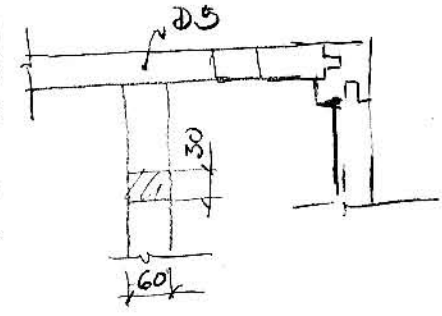
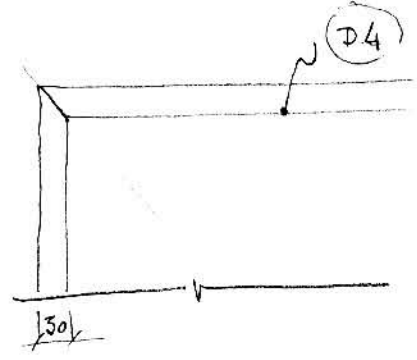
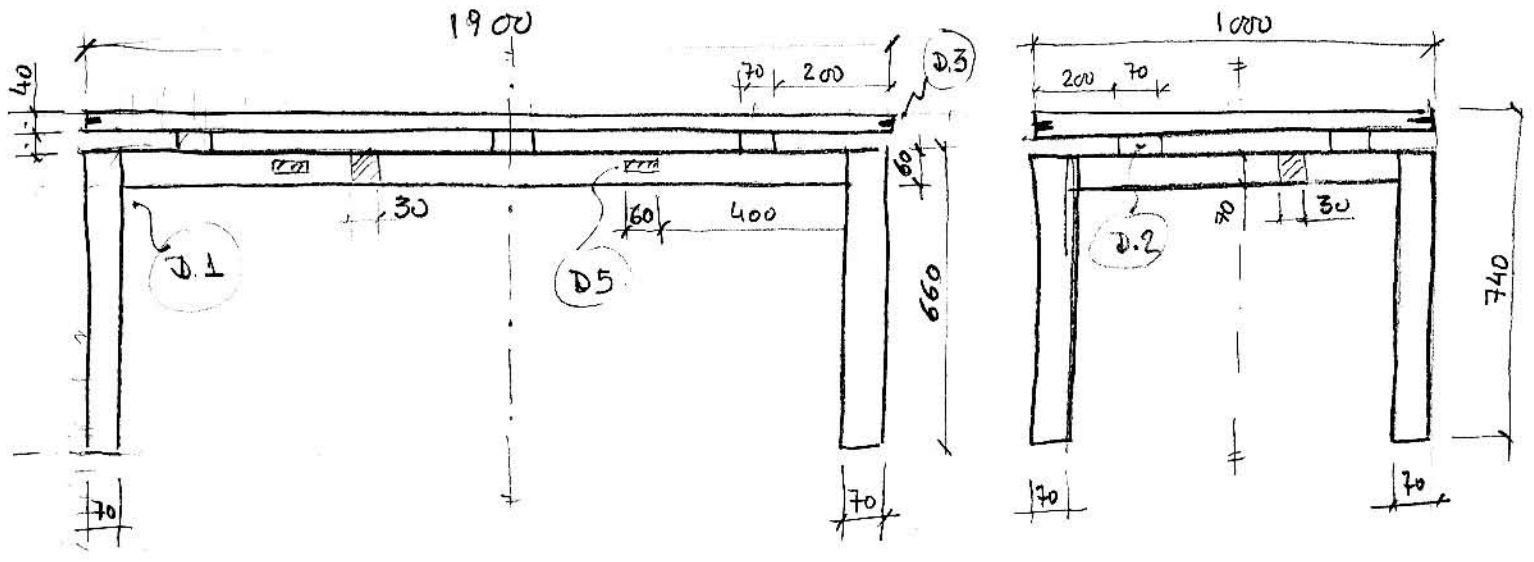

D.2 Union a tope encolada.

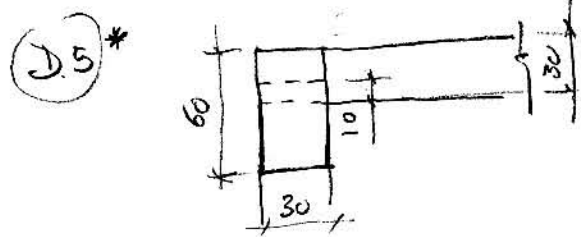
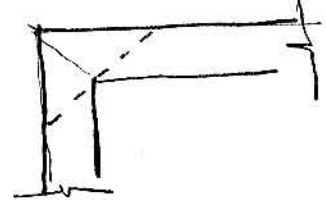
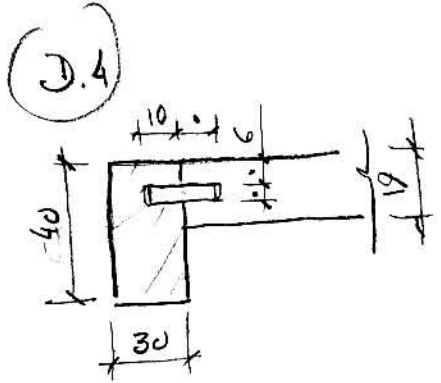
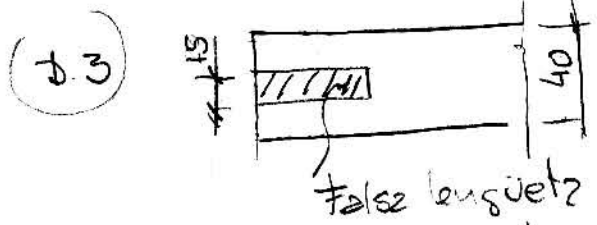

\* Opcion: ANULAR.

MESAJONER "EDEN"  
 - Daniel Ezan -  
 R. Bobois

HOJA DE CONTROL DE MATERIALES: DESPIECE - VOLUMEN - SUPERFICIE - COSTE

PROYECTO DE TRABAJO:

ALUMNO:

Nº	DENOMINACIÓN	UDS.	Largo	Ancho	Grueso	Espigas	Material	Volumen mm <sup>3</sup>	Superficie mm <sup>2</sup>	Total Neto		Desperdicio		TOTAL BRUTO		PRECIO IVA incl m <sup>3</sup> /m <sup>2</sup>	COSTE
										m <sup>3</sup>	m <sup>2</sup>	m <sup>3</sup>	m <sup>2</sup>	m <sup>3</sup>	m <sup>2</sup>		
												30%	15%				
1																	
2																	
3																	
4																	
5																	
6																	
7																	
8																	
9																	
10																	
11																	
12																	
13																	
14																	
15																	
16																	
17																	
18																	
19																	
20																	
21																	
22																	
23																	
24																	
25																	
<b>TOTALES</b>																	

