

ANEXO

X / HERRAMIENTAS DE ALISAR - RASCAR - PULIR

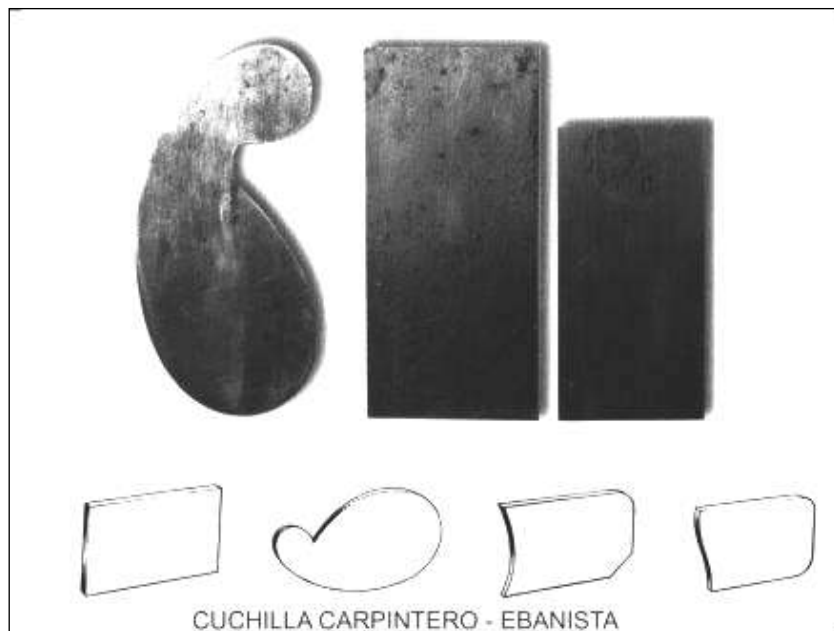

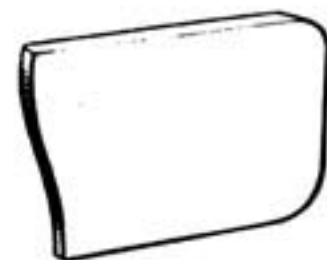
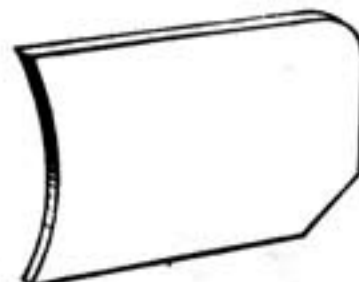

CUCHILLA CARPINTERO - EBANISTA

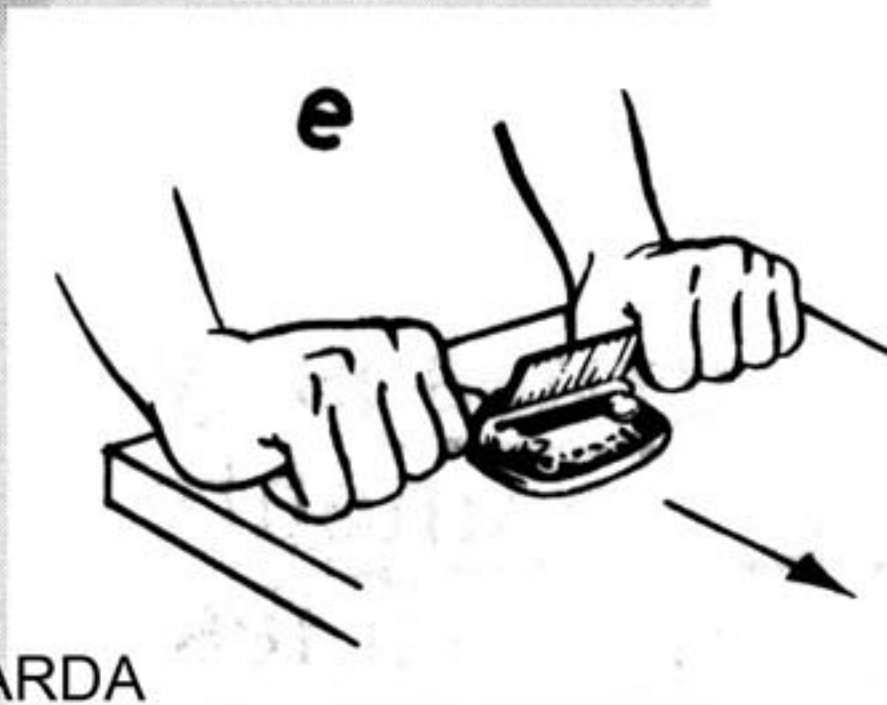
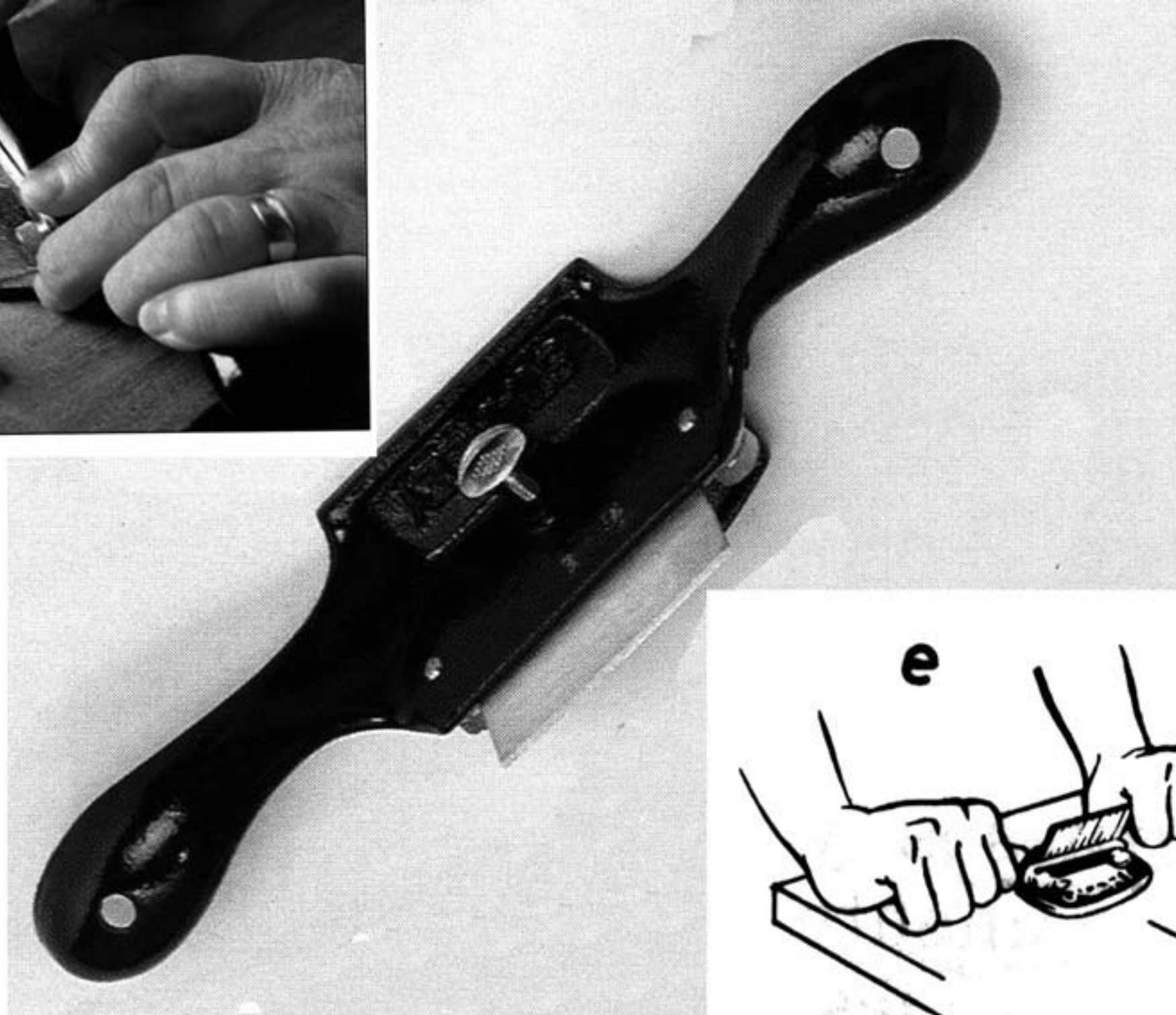

RASQUETA DE EBANISTA - GUIMBARDA

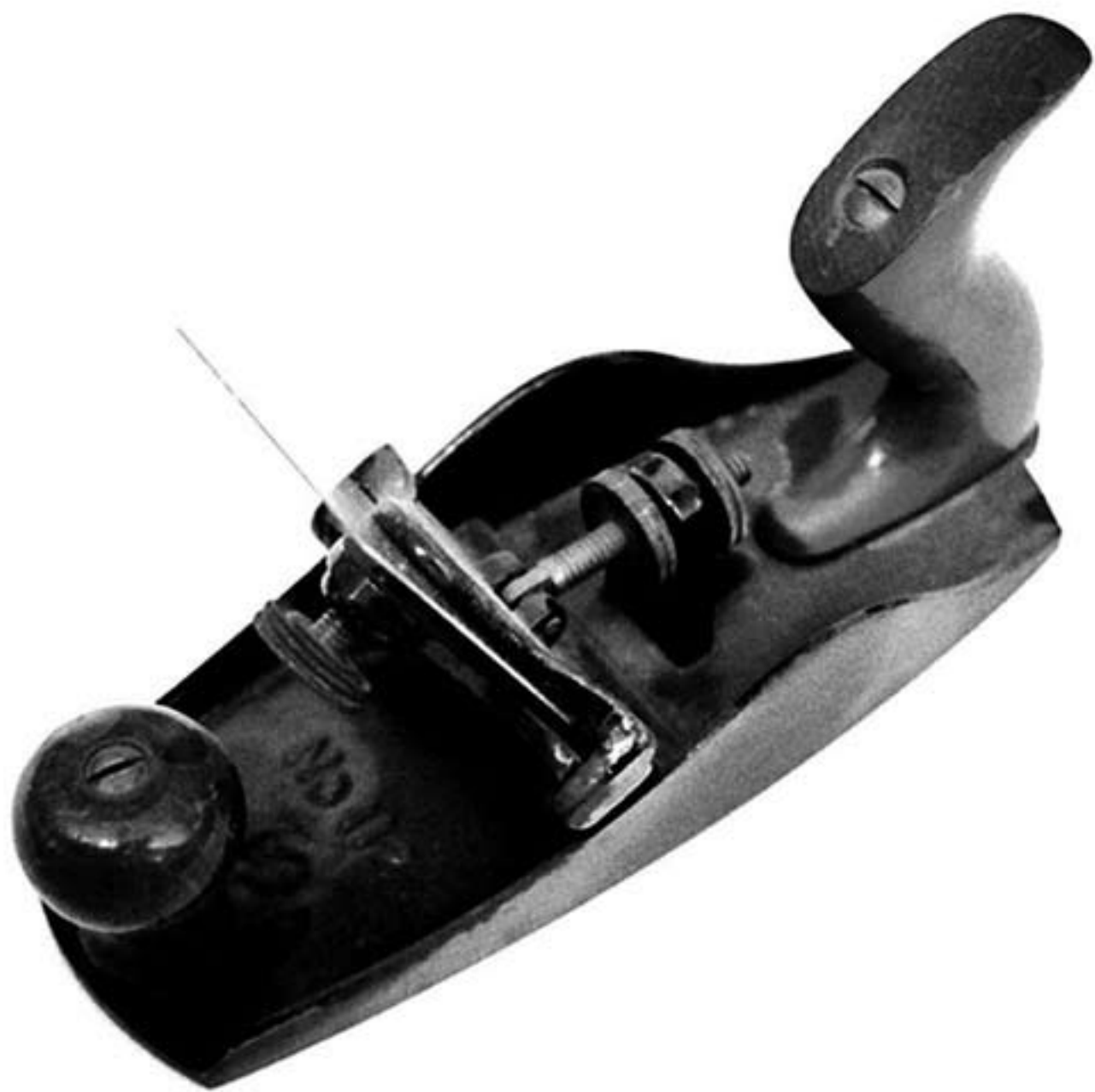

CEPILLO PORTACUCHILLA

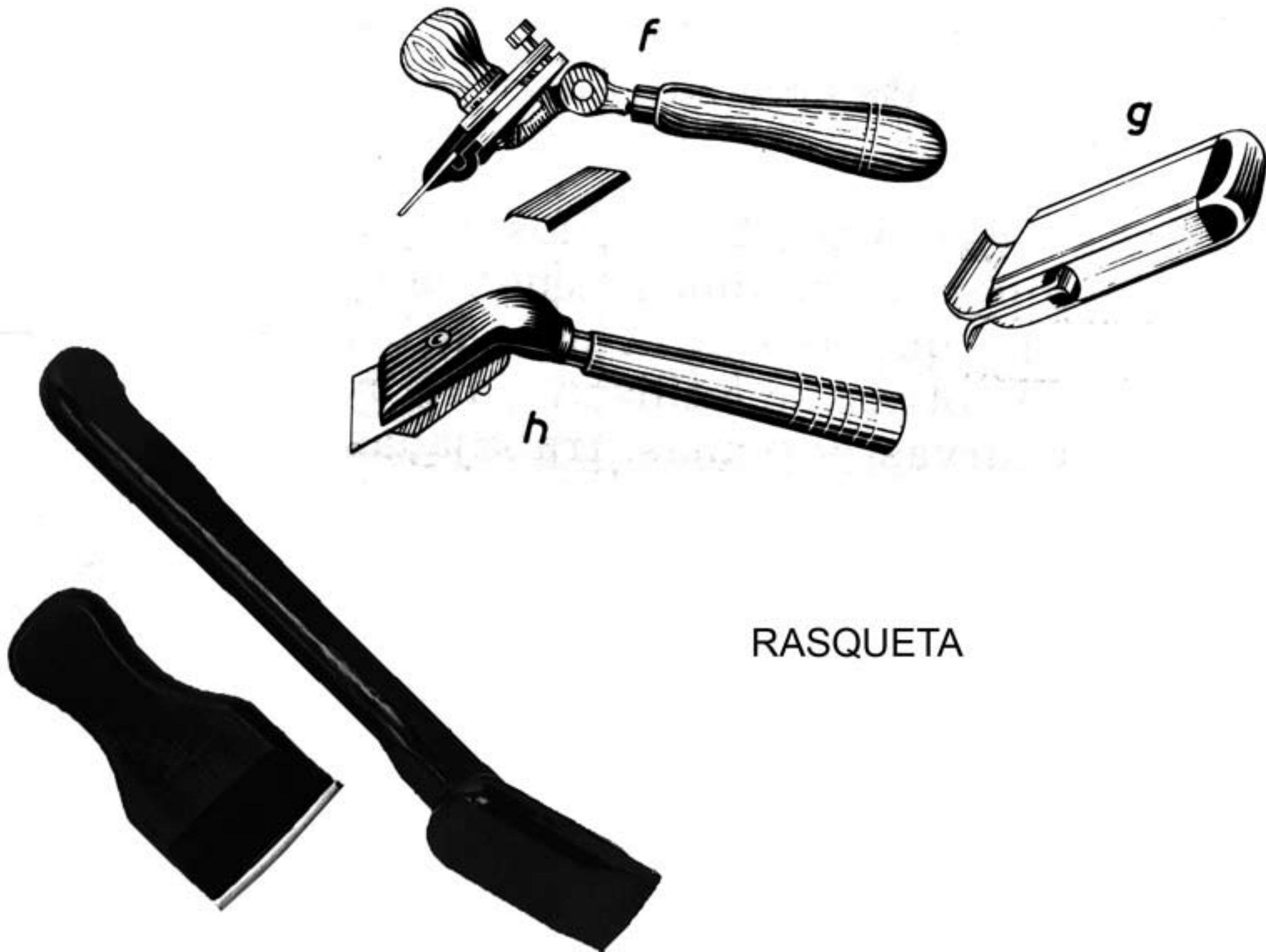

RASQUETA



CHAIRA - BRUÑIDOR

SIN REBABA



CON REBABA

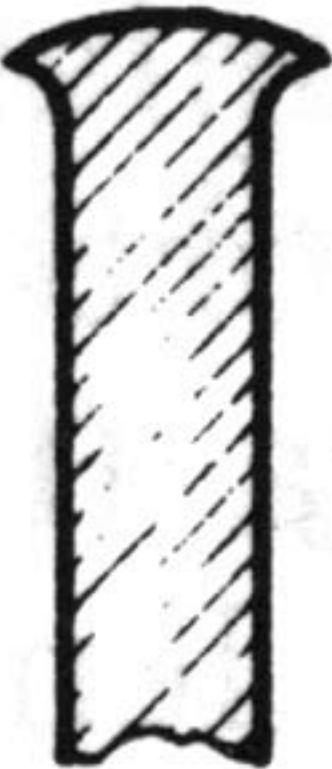

CON CHAFLÁN
Y REBABA



FILO DE CUCHILLA

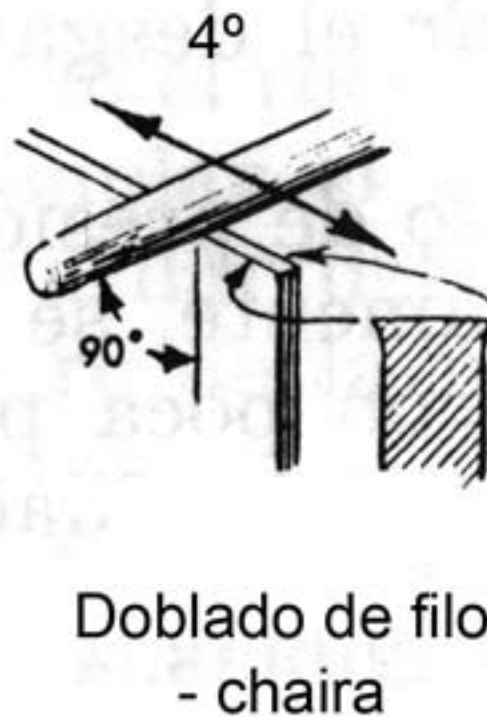

CUCHILLA - AFILADO

