

# ANEXO

## VI / ESCOFINAS Y LIMAS



Limas de aguja



Mango



Escopфина de media caña

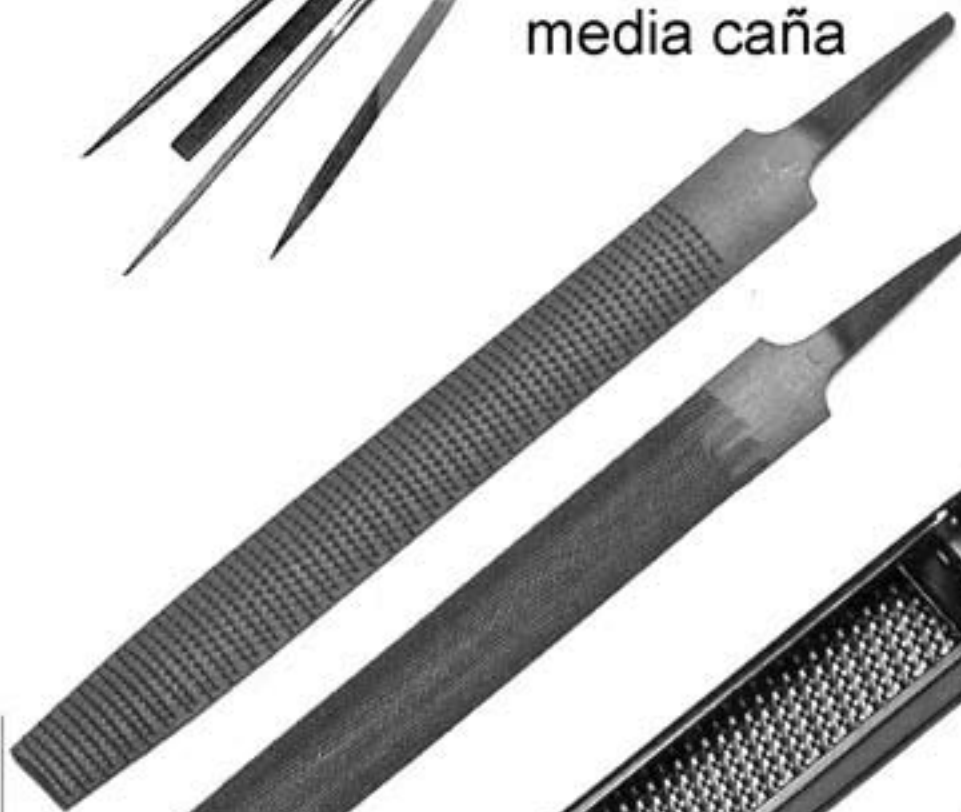

Lima de media caña



Lima Surform plana

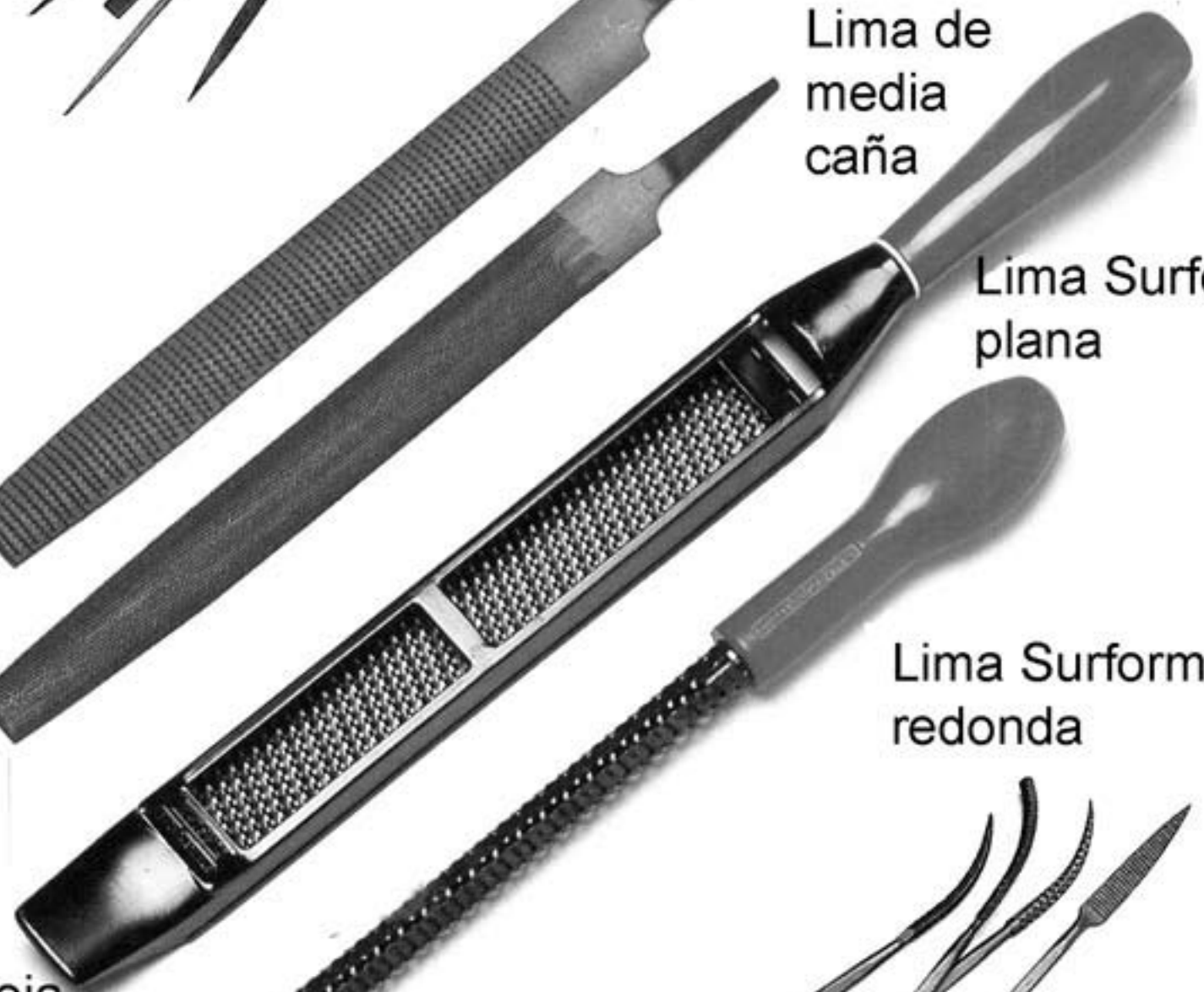

Lima Surform redonda

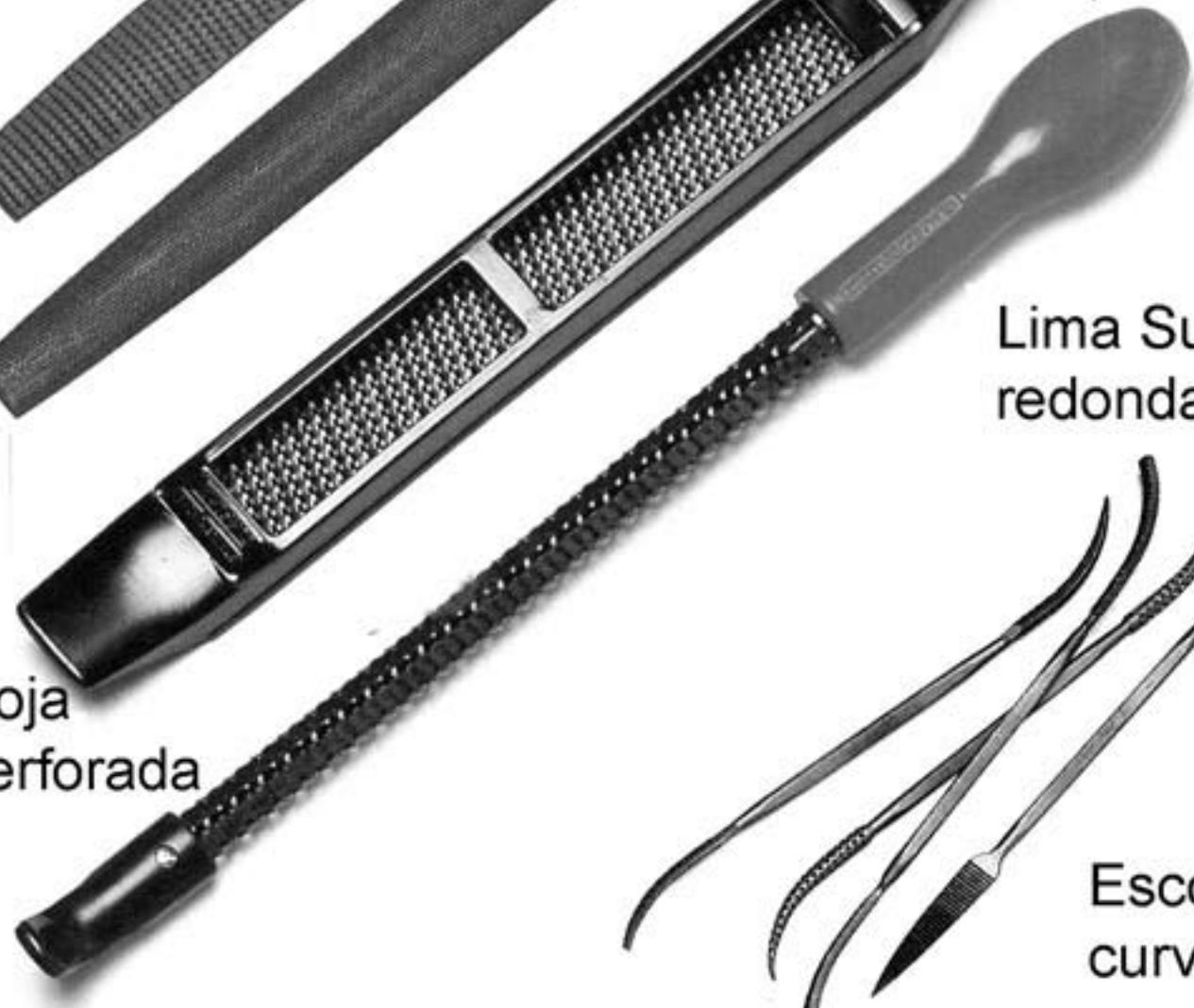

Hoja perforada

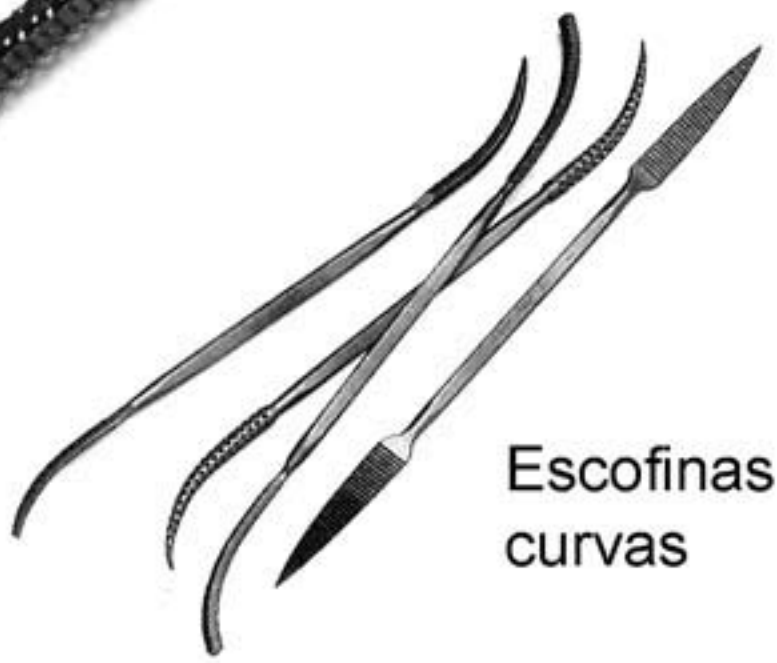

Escopfinas curvas



Lima de media caña

Lima triangular

Limatón

Lima plana

Escofina redonda



Escofina de media caña



# SISTEMA SURFORM

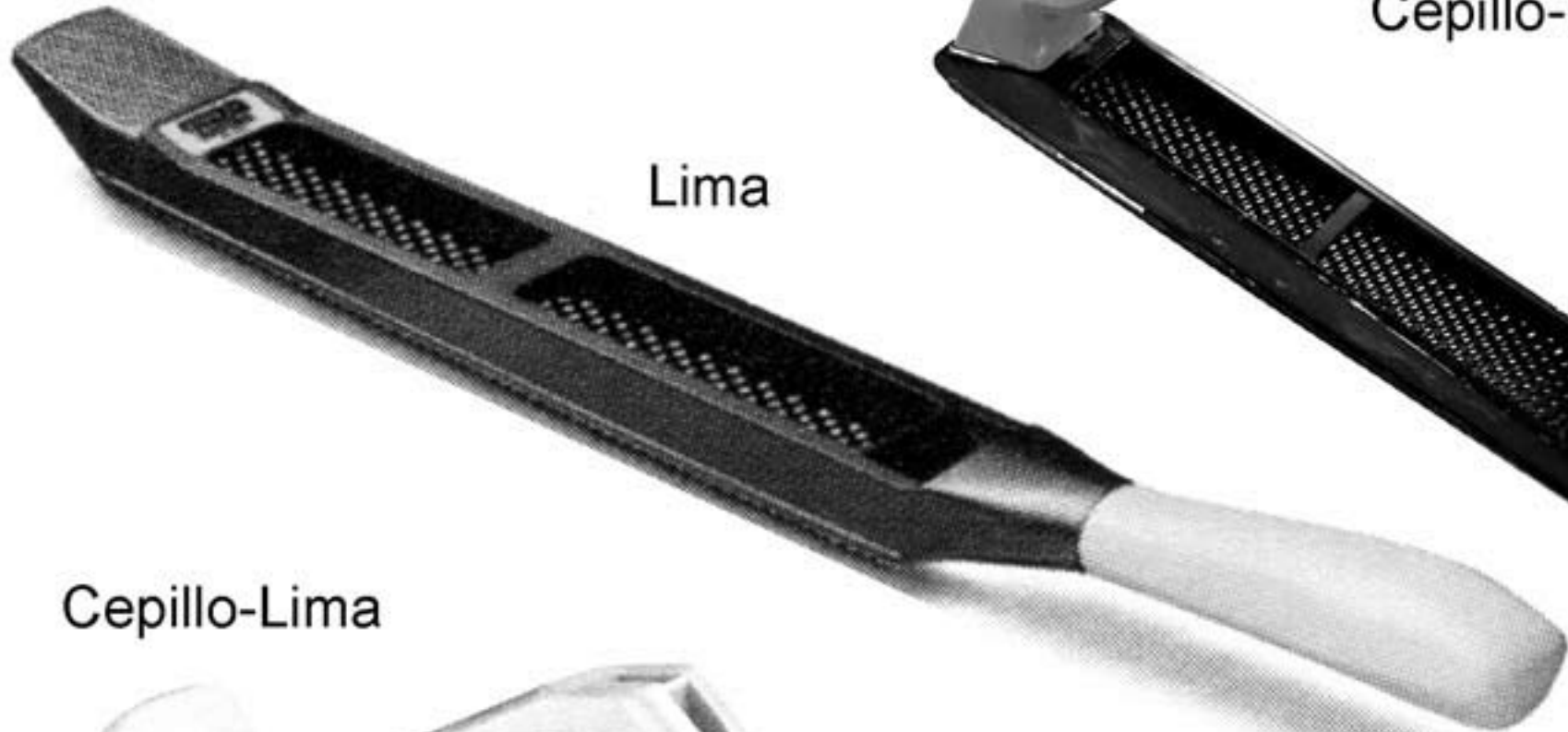

Lima



Cepillo-Lima

Cepillo-Lima

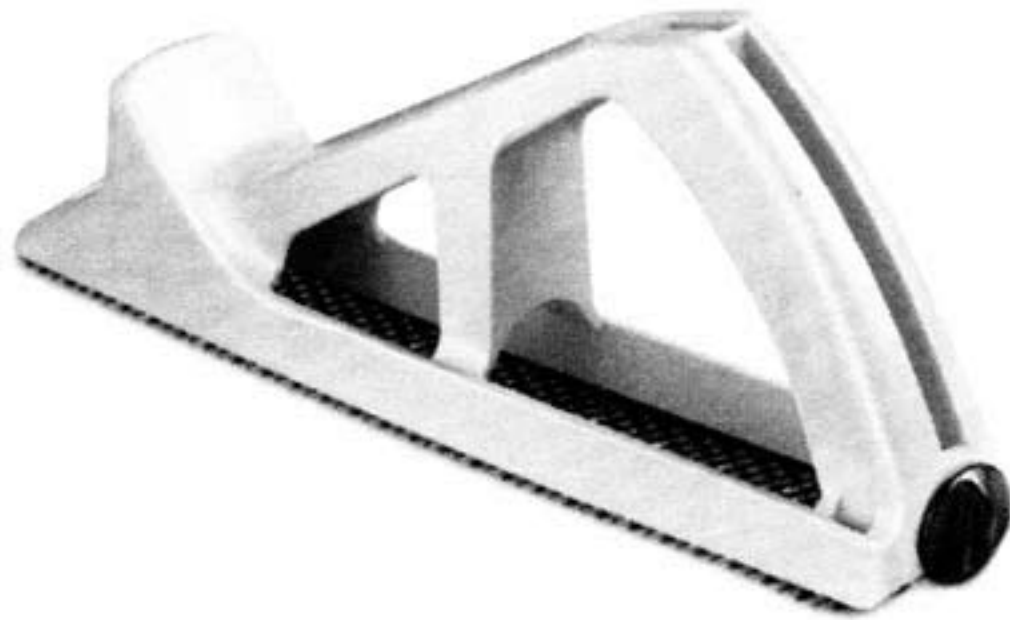

Mini Lima

# SISTEMA MICROPLANE



Microplane de perfil redondo



Microplane de perfil de esquina



Hoja redonda fina Microplane



Hoja redonda basta Microplane

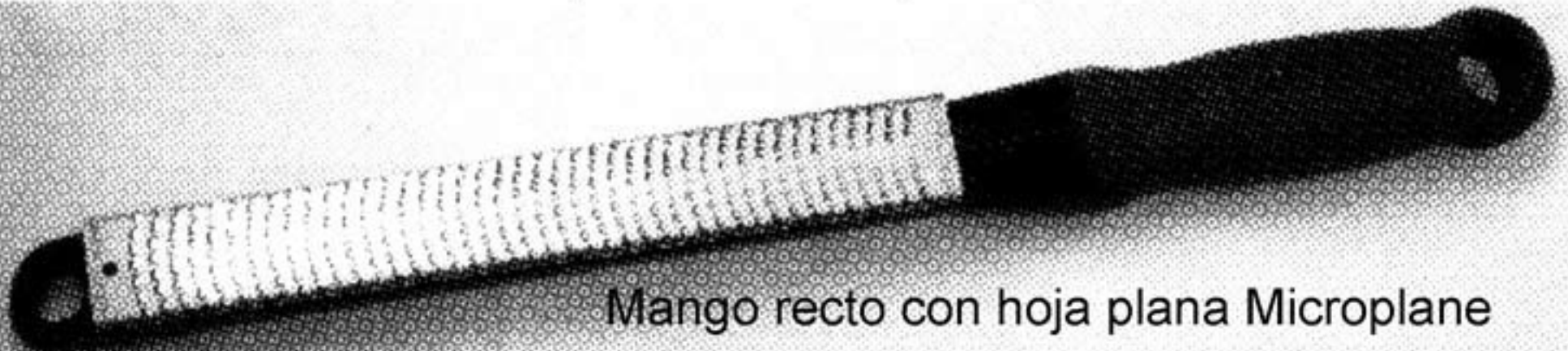

Mango recto con hoja plana Microplane



# SISTEMA MICROPLANE

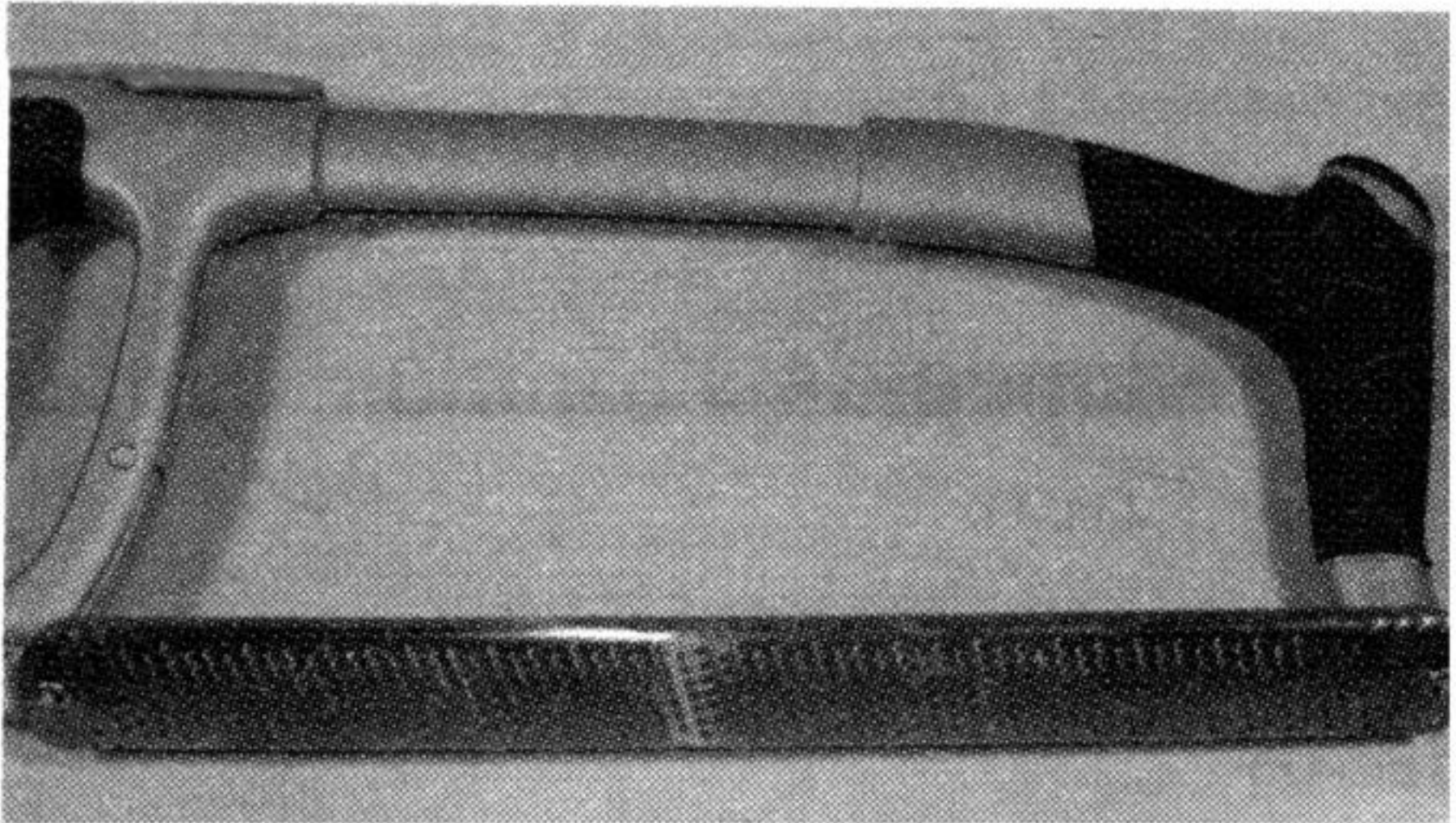

Arco de sierra con hoja de lijado Microplane



Hoja flexible de lijado Microplane para arco de sierra

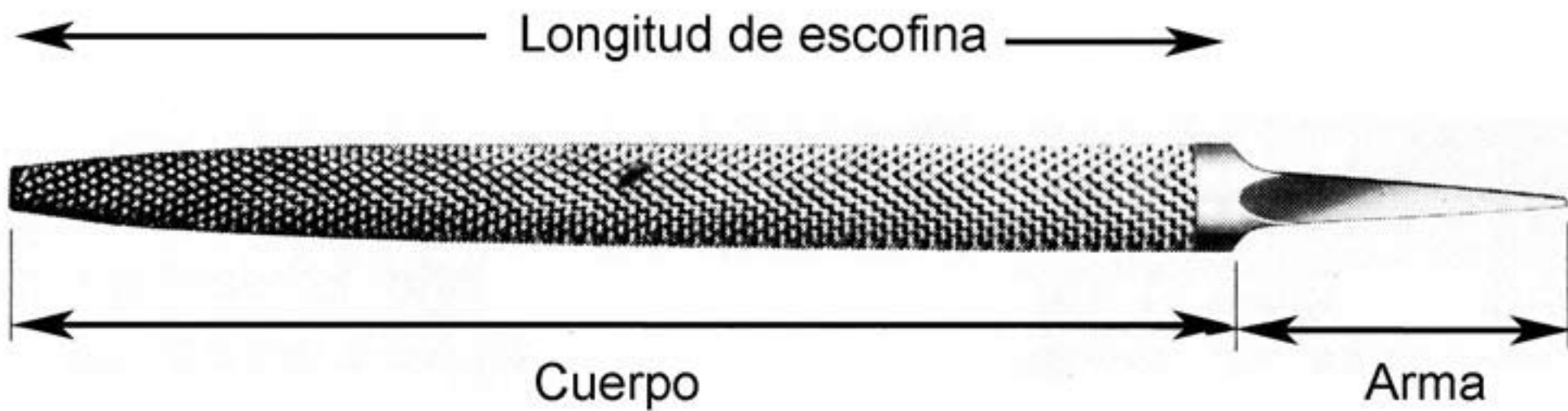

PARTES DE LIMA Y ESCOFINA



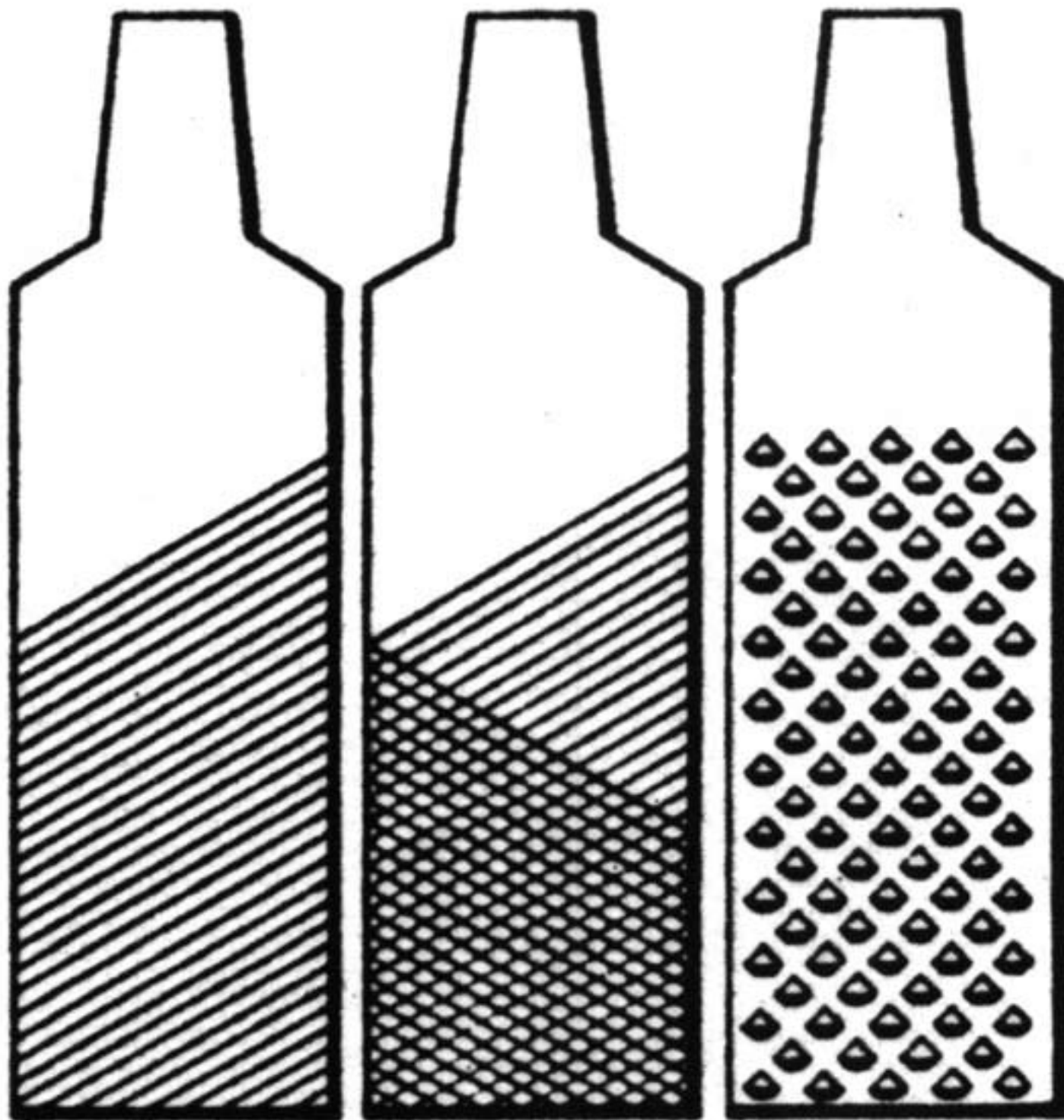

SUPERFICIE DE LIMA Y ESCOFINA

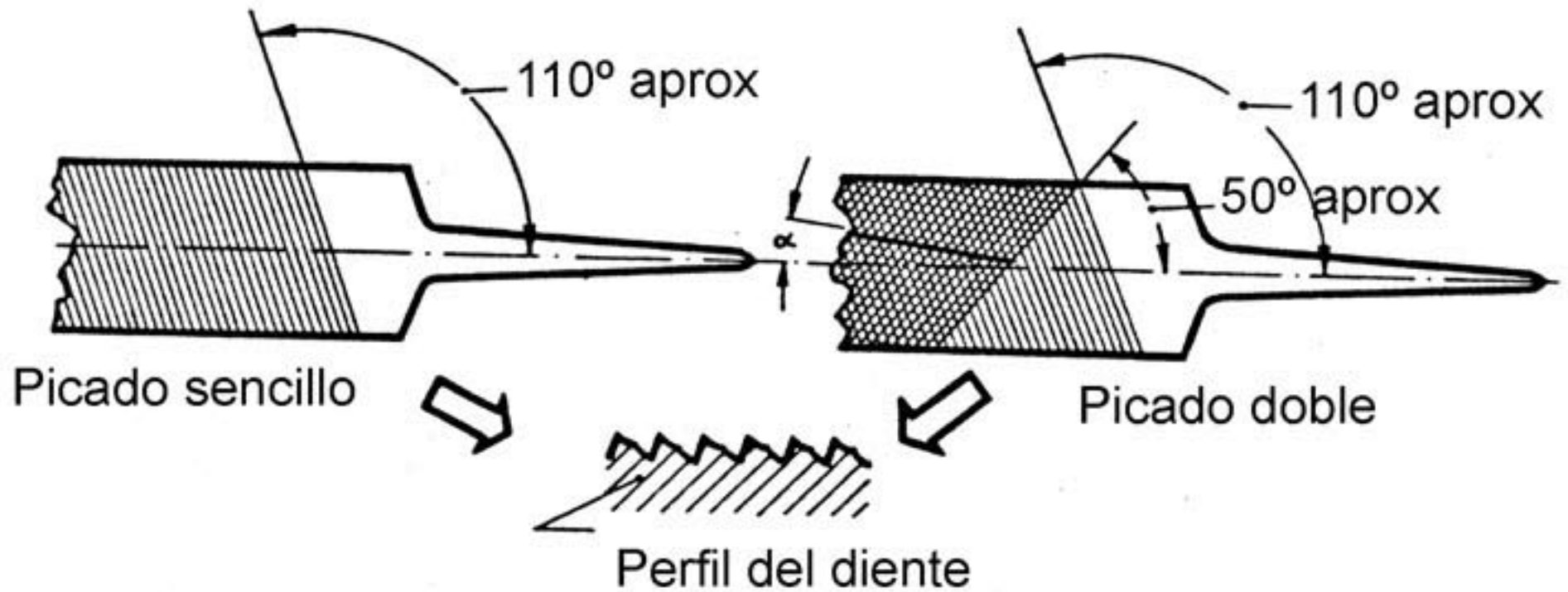

PICADO DE LIMA



Picado de escofina



Perfil del diente

Media caña

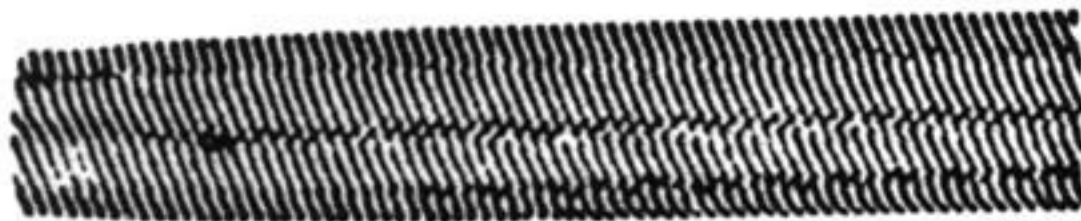

Redonda



Triangular



Plana



Cuadrada



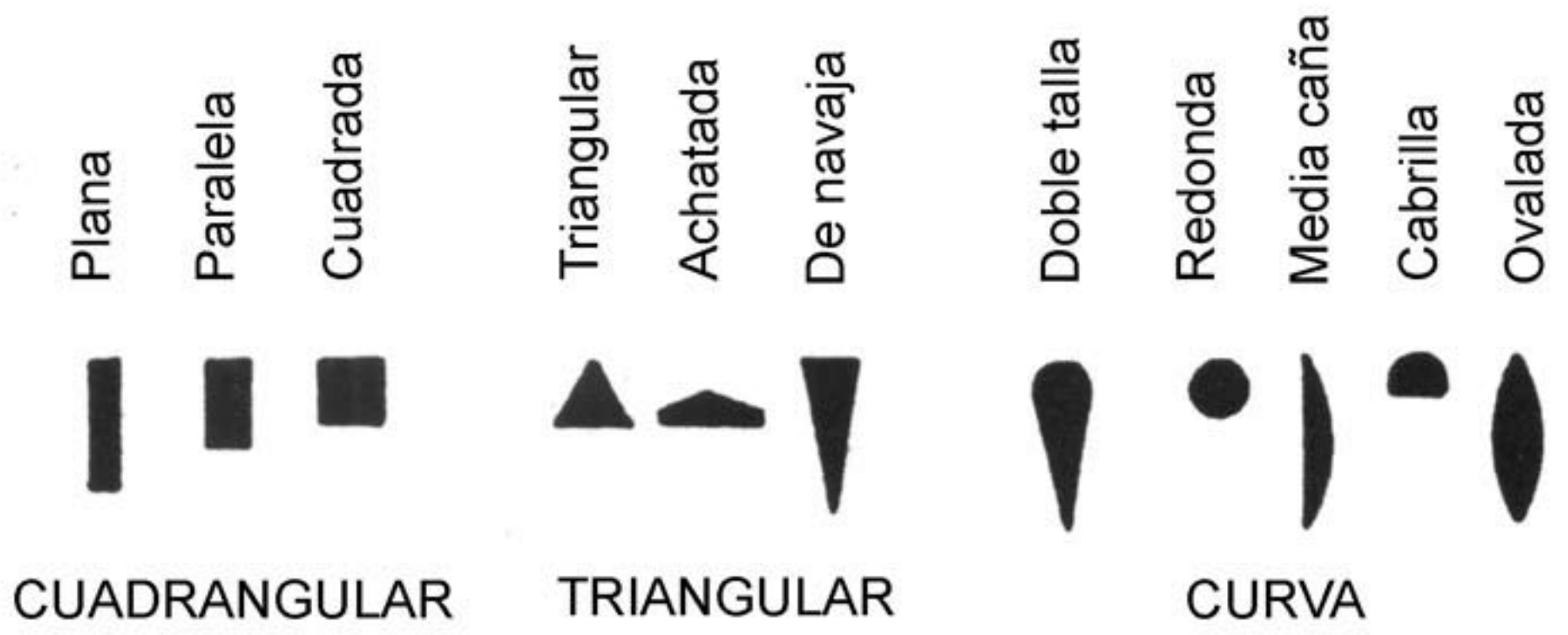

SECCIONES DE LIMAS



Mini lima

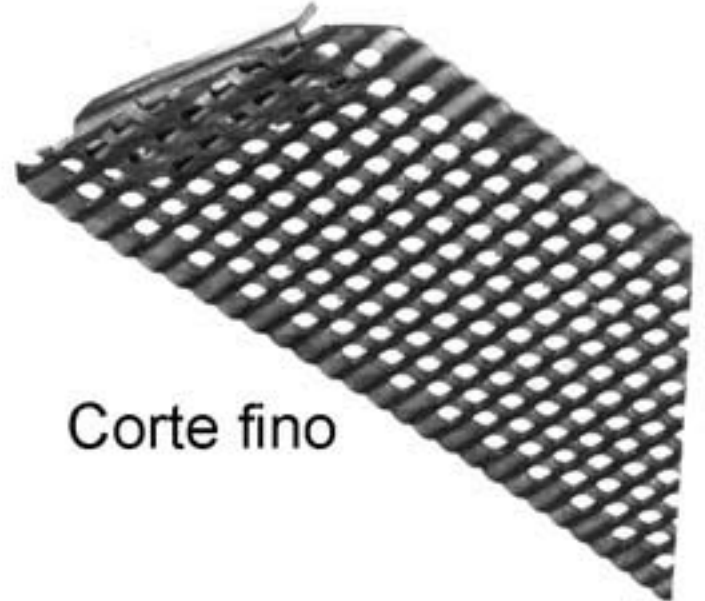

Corte fino



Redonda



Semicurvada



Para metal ligero y plásticos

HOJAS DE SURFORM



CARDA



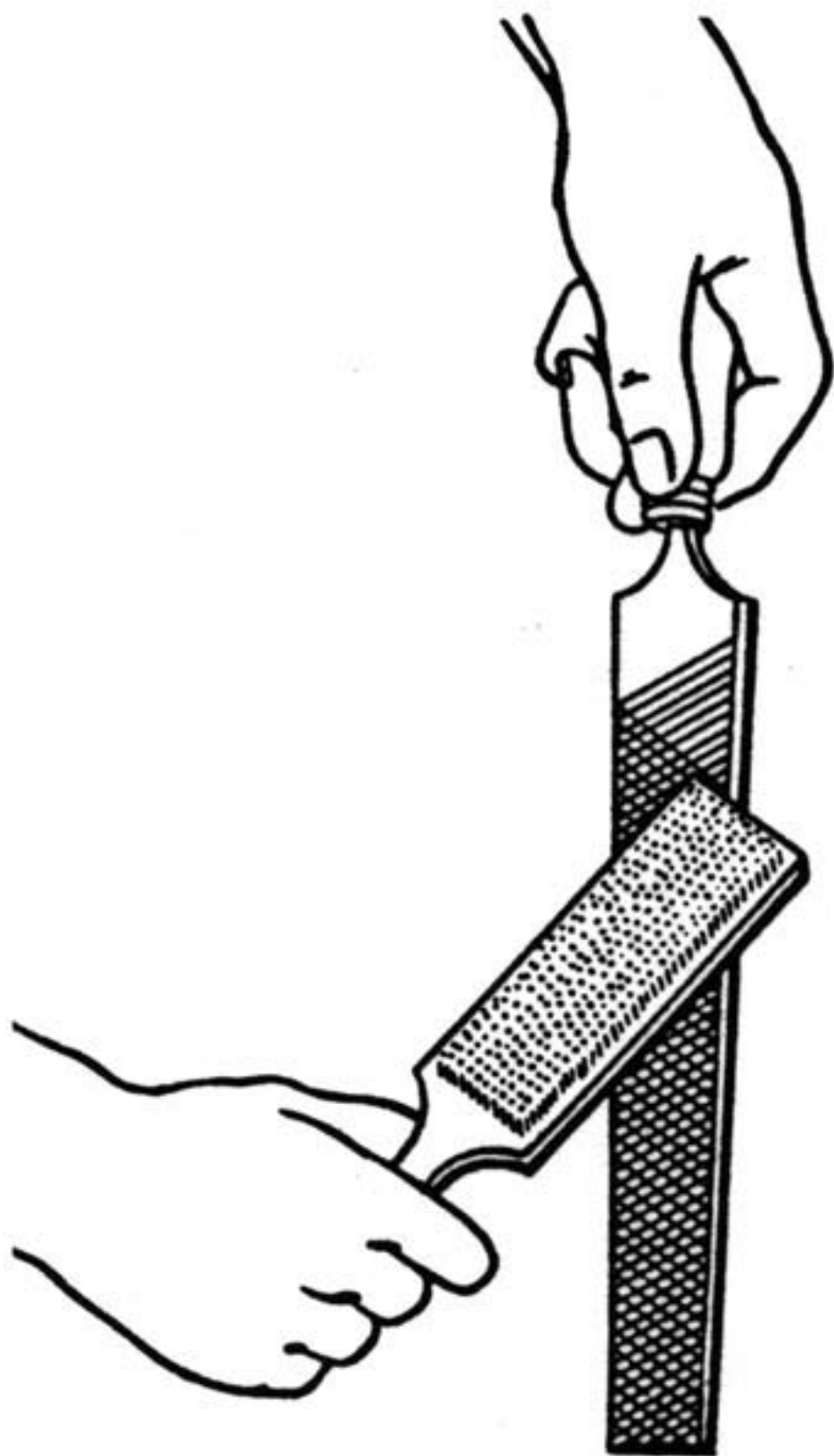

LIMPIEZA DE LIMA CON CARDA

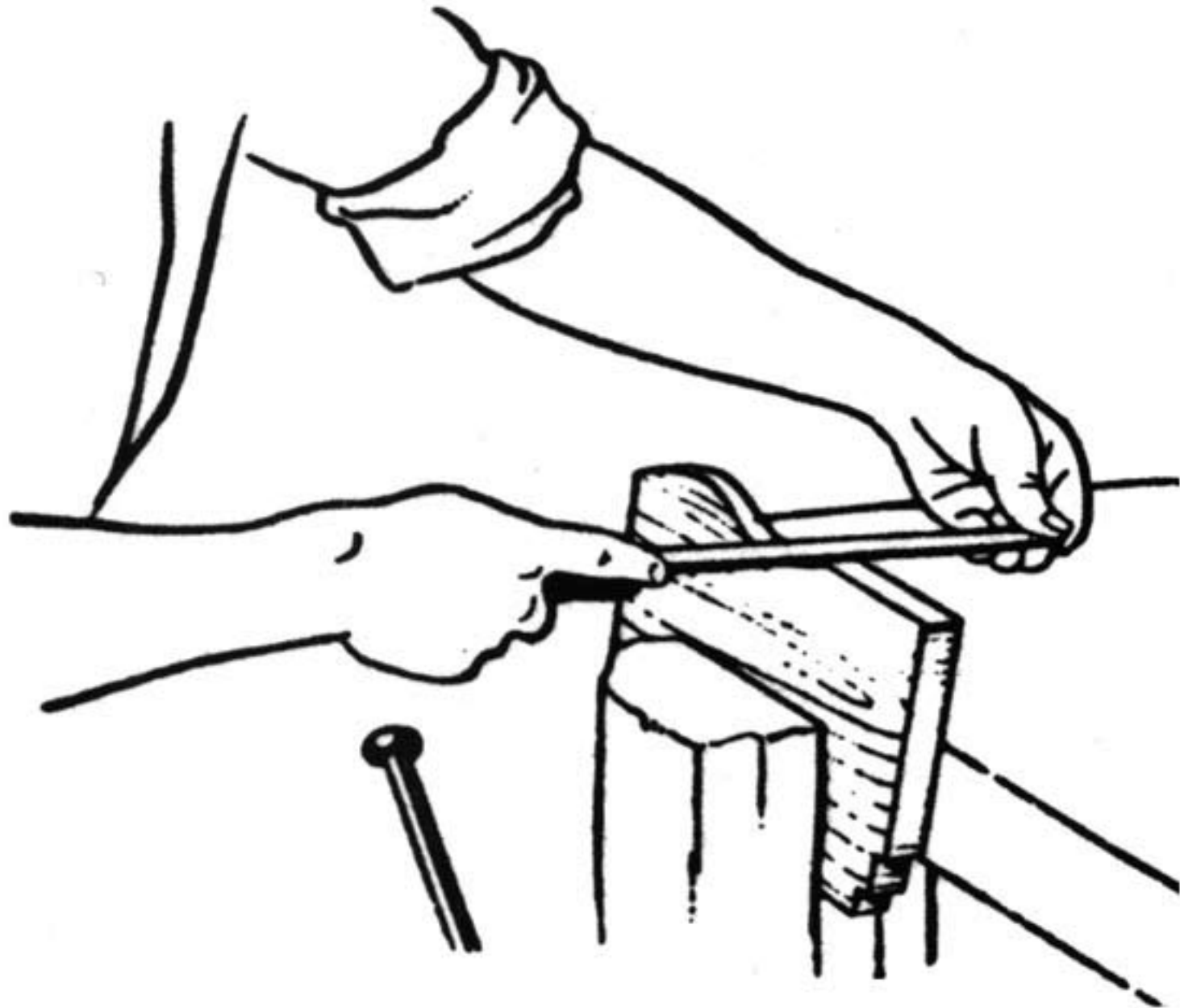

MANEJO DE LIMA - ESCOFINA