

ANEXO

I / HERRAMIENTAS E INSTRUMENTOS DE SOSTENER

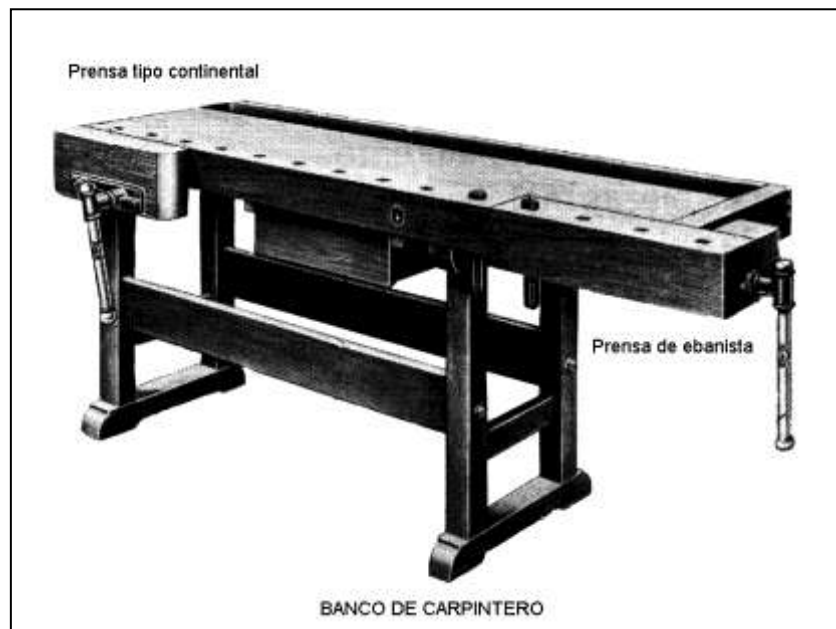



BANCO DE CARPINTERO CON PRENSA VERTICAL



BANCO DE CARPINTERO CON PRENSA VERTICAL

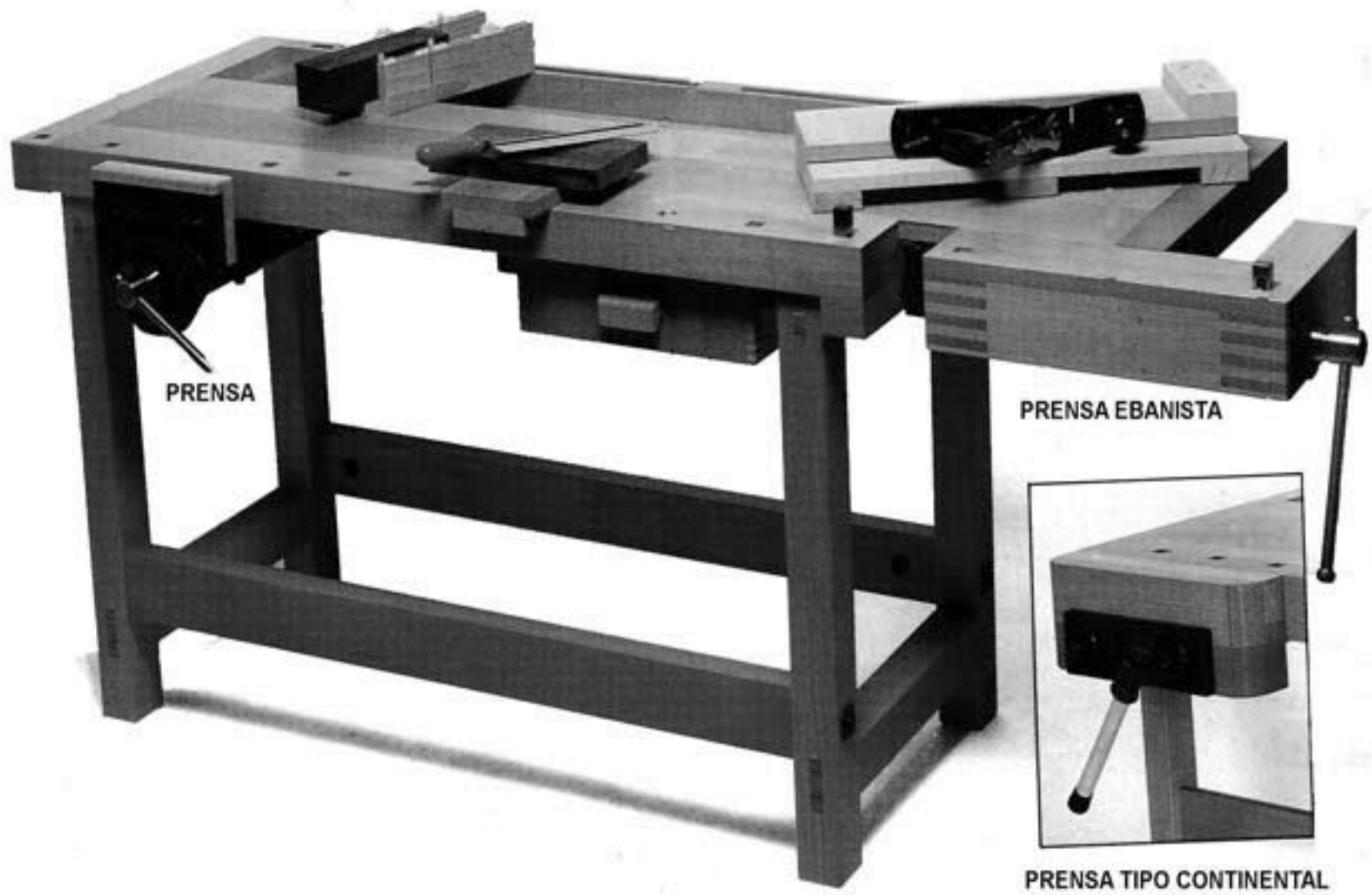

PRENSA

PRENSA EBANISTA

PRENSA TIPO CONTINENTAL

BANCO DE CARPINTERO

Prensa tipo continental



Prensa de ebanista

BANCO DE CARPINTERO



BANCO DE CARPINTERO PLEGABLE

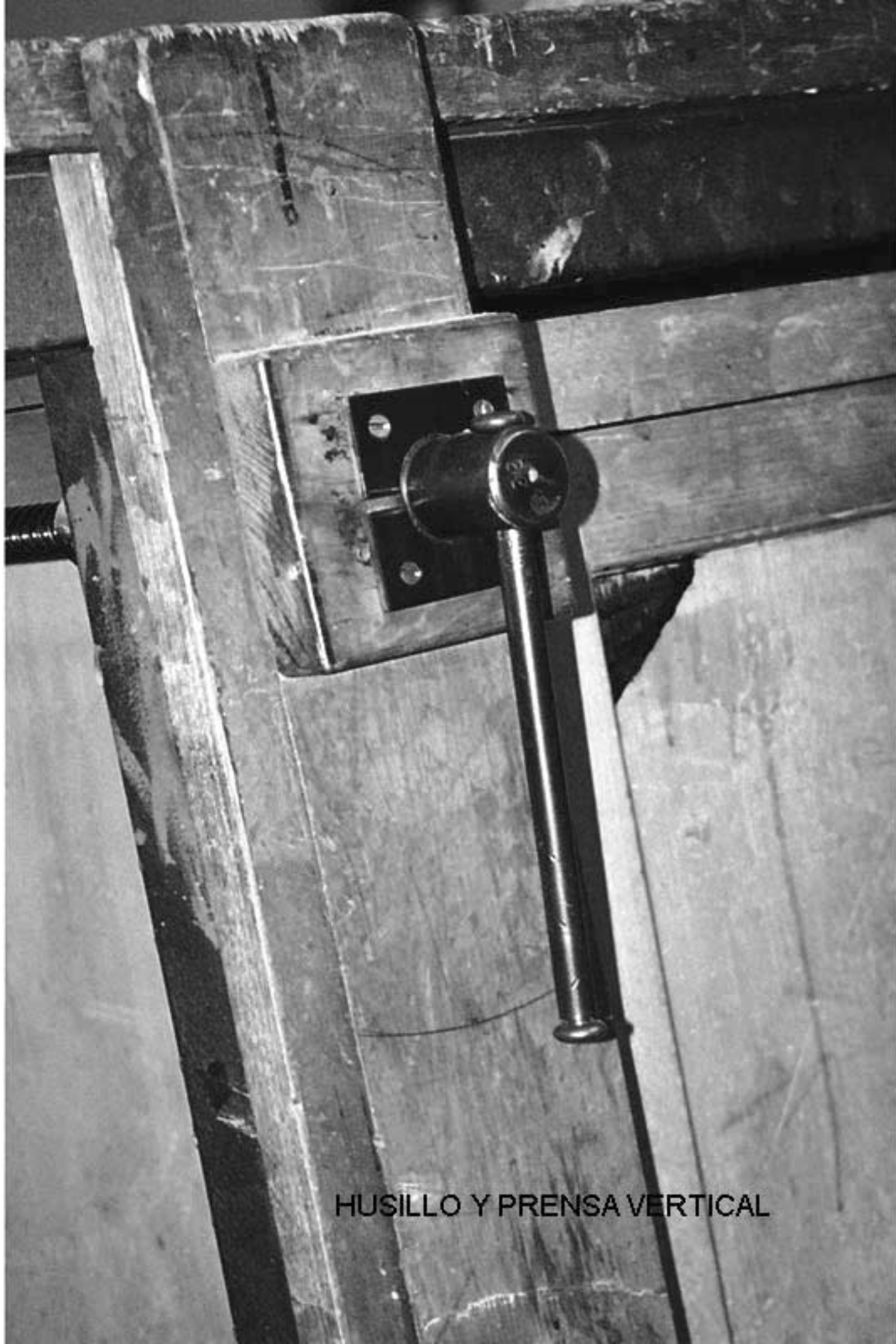

HUSILLO Y PRENSA VERTICAL



HUSILLO DE PRENSA VERTICAL DE BANCO

A black and white photograph of a wooden table. The table has a central longitudinal groove and a smaller groove on the right side. The wood grain is visible, and there are some dark spots or stains on the surface. The word "PESEBRE" is printed in a bold, sans-serif font in the center of the image.

PESEBRE



CORCHETE (formado por dos cuñas)

Presión para bloquear

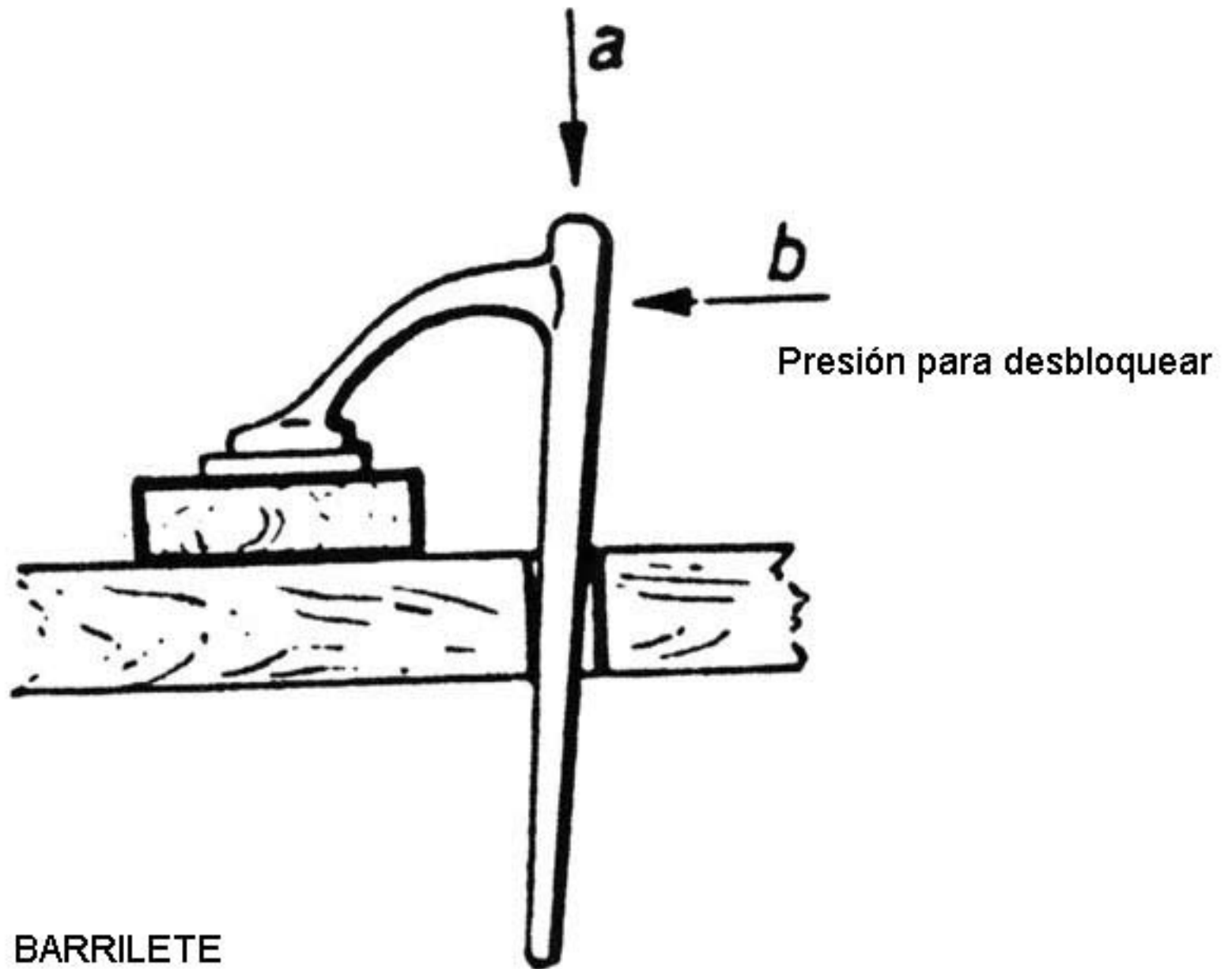

Presión para desbloquear

BARRILETE

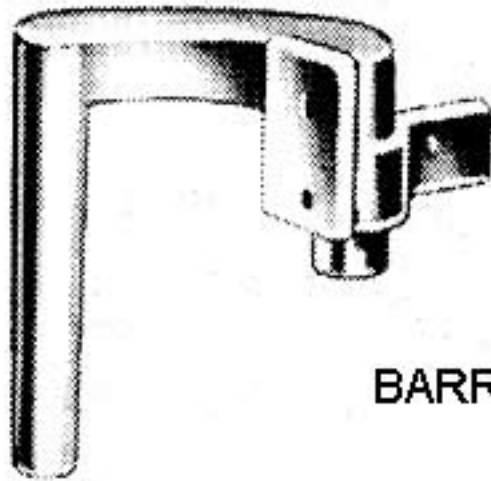
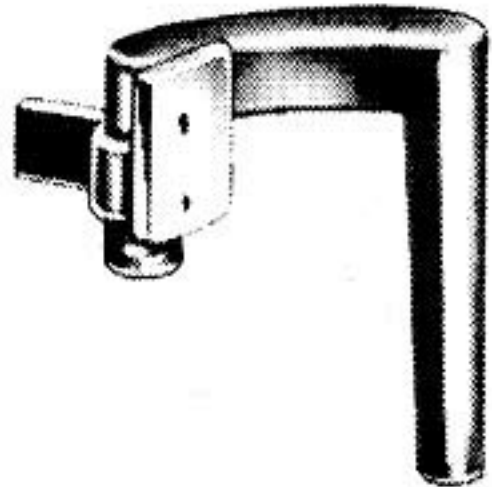
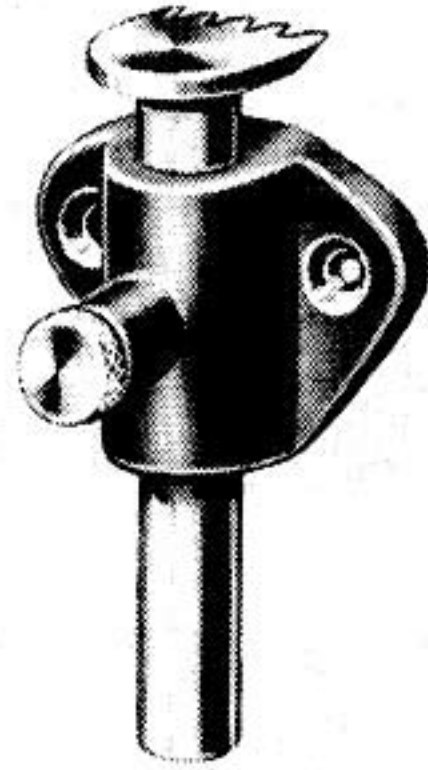
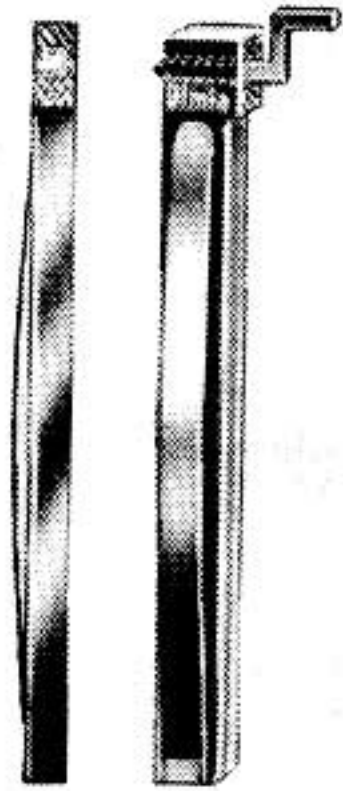

BARRILETE

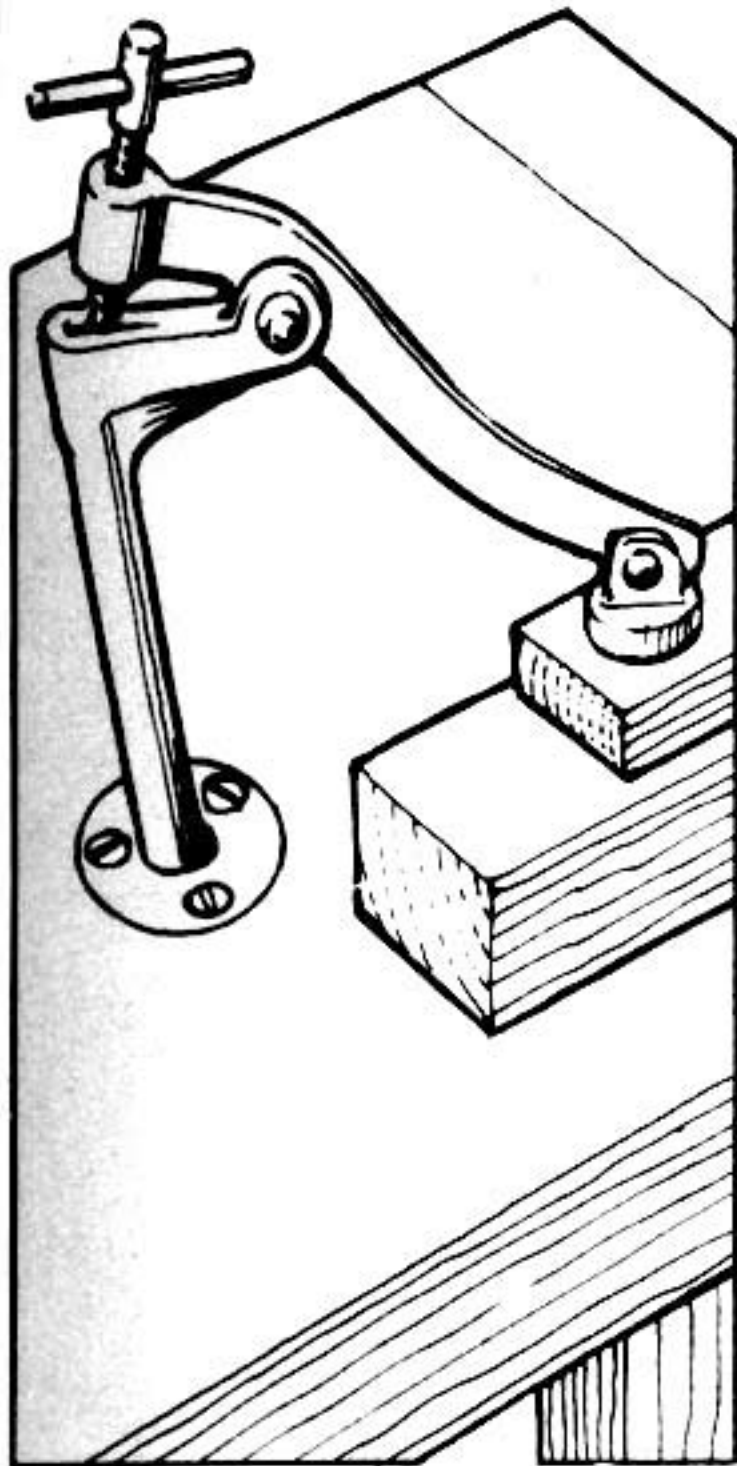

BARRILETE FIJADO A BANCO

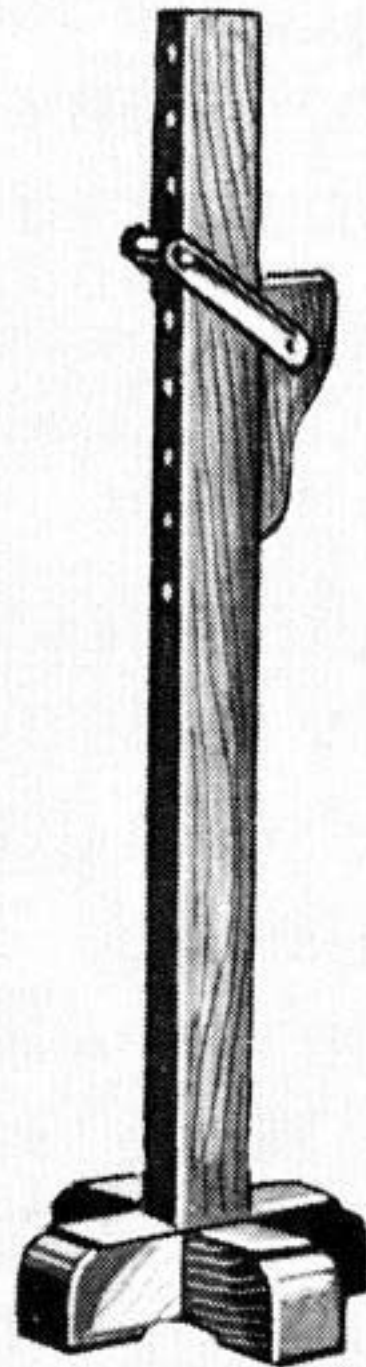

CABALLETE DE COLUMNA / SIRVIENTE

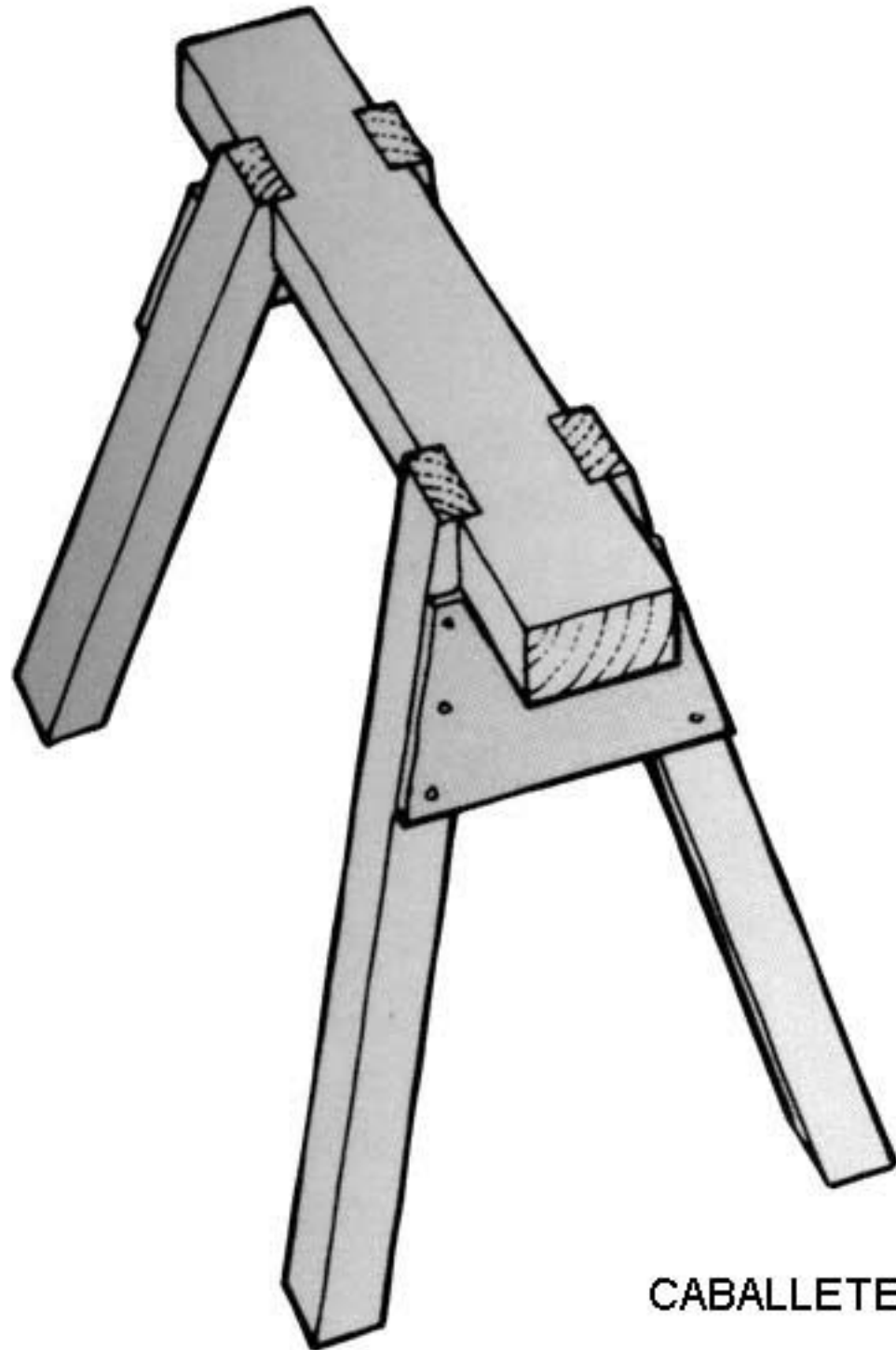

CABALLETE



SOPORTE CORTADOR

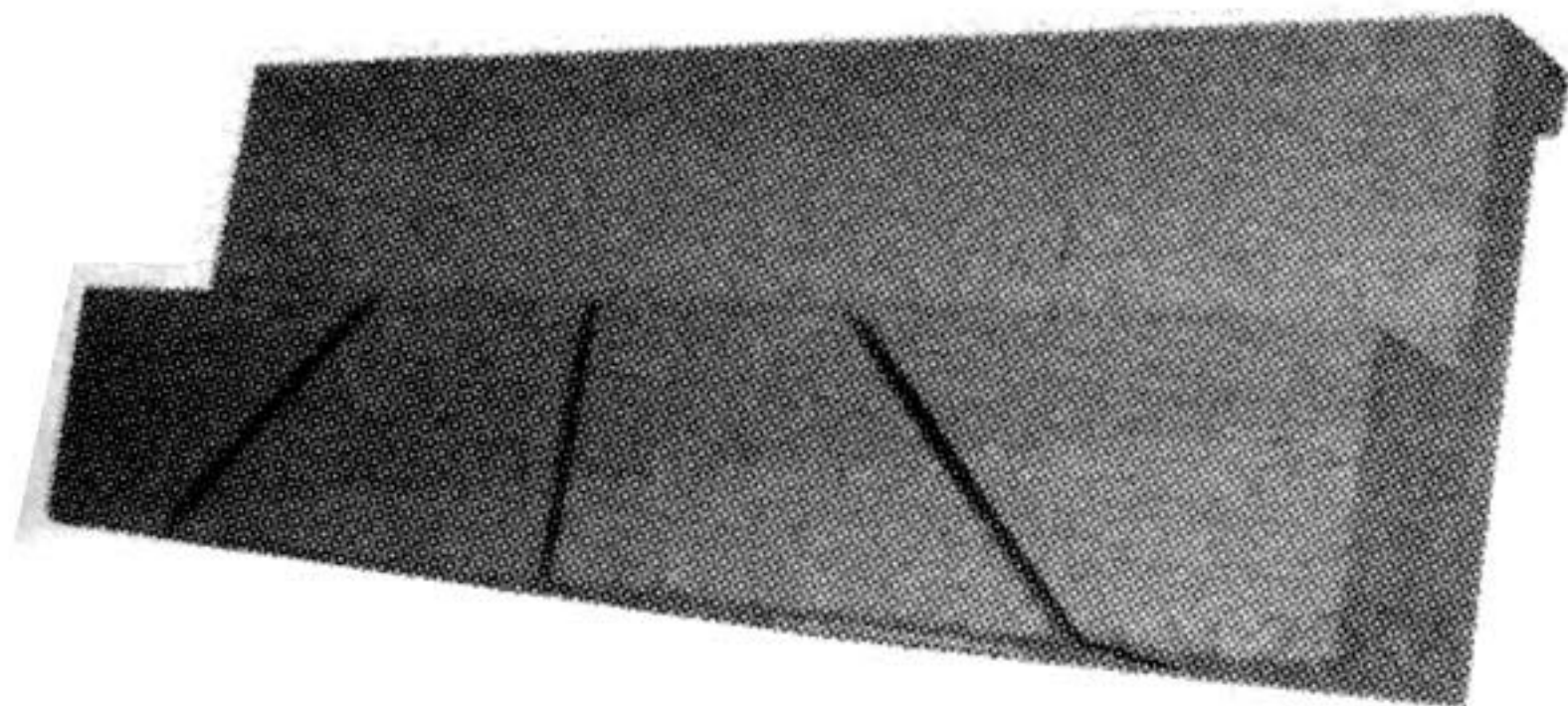

SOPORTE CORTADOR DE INGLETES

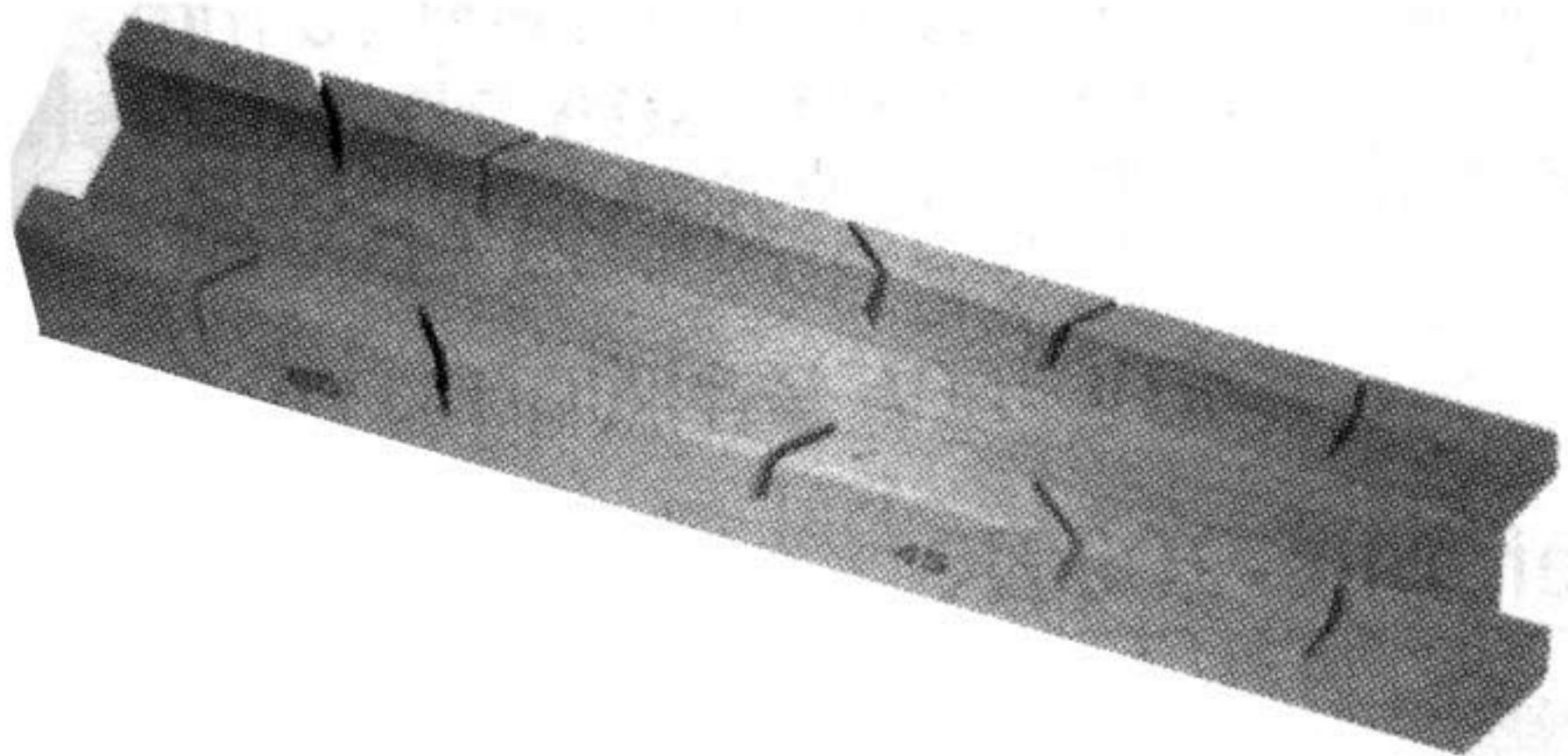

SOPORTE CORTADOR DE INGLETES - TIPO CAJA

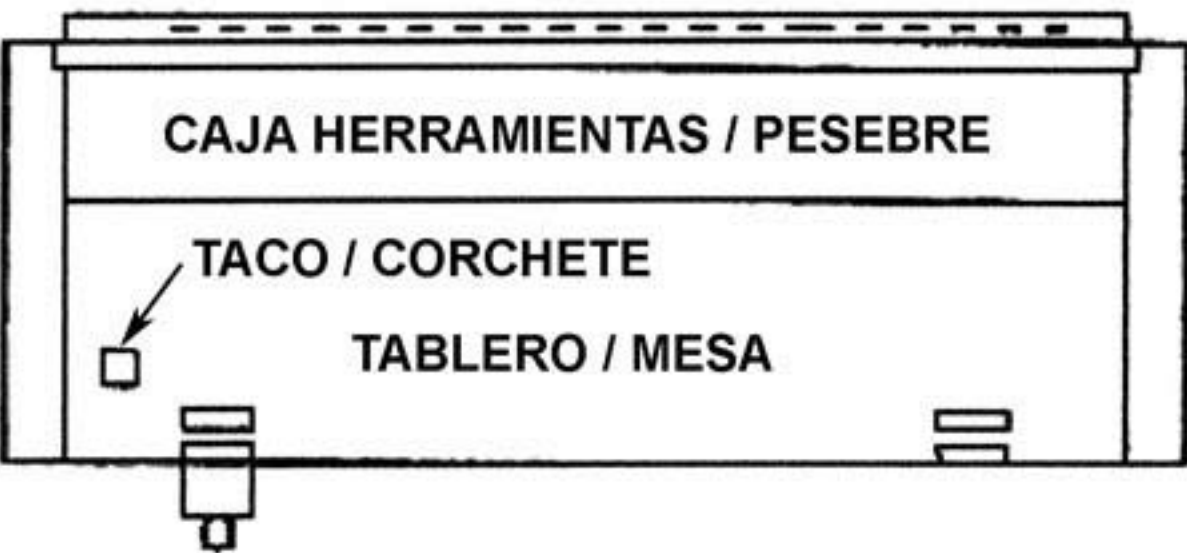

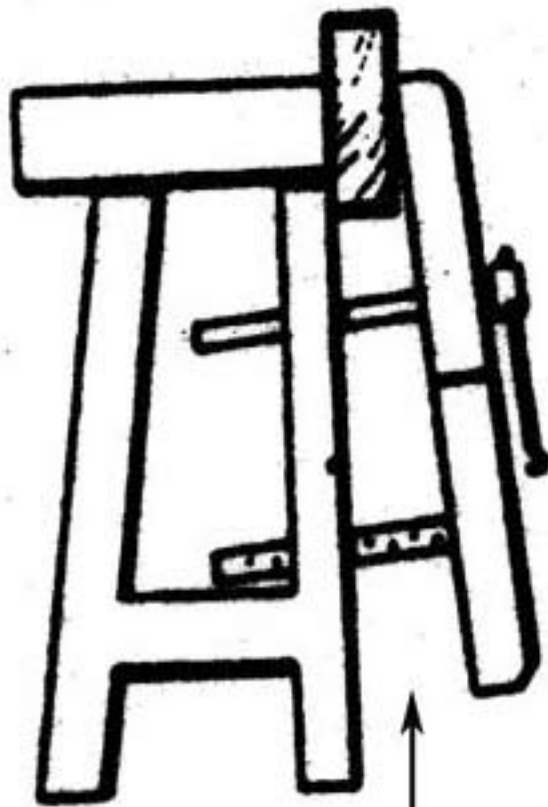

MAL

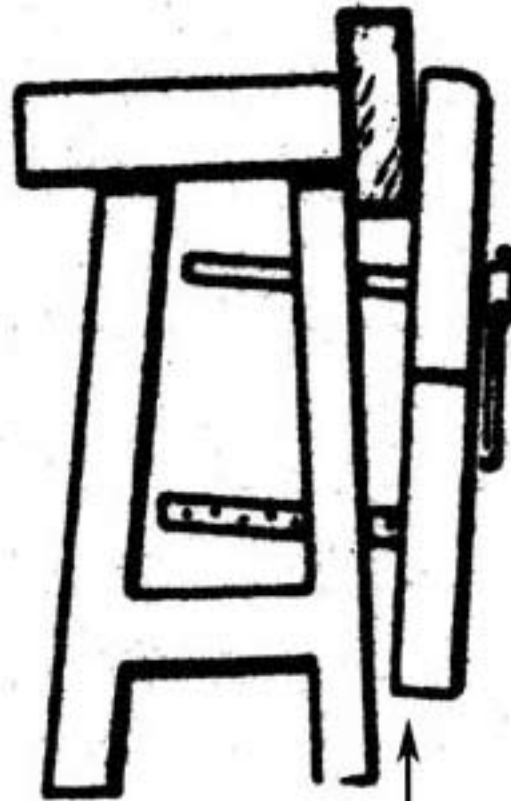

MAL

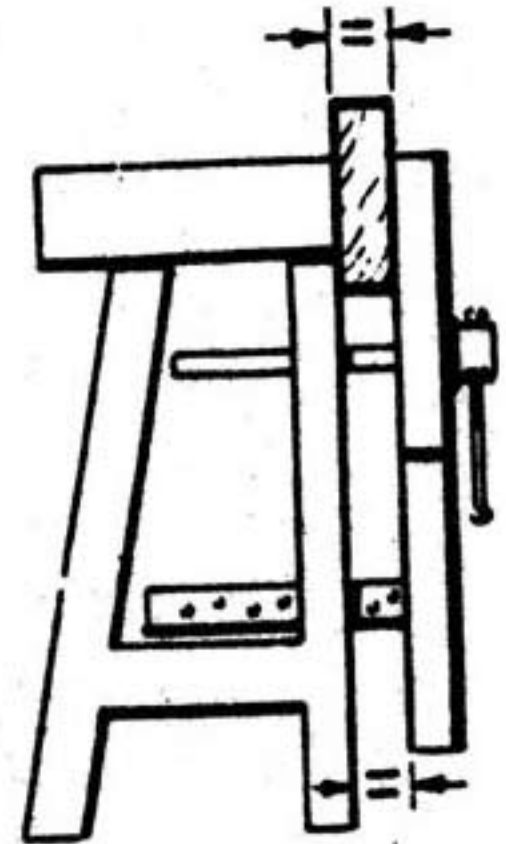

BIEN

Separación paralela de
la prensa y la pata del banco

MANEJO DE LA PRENSA VERTICAL